

MUTOH

The background features a stylized globe of the Earth in shades of blue, positioned in the lower right. It is surrounded by several overlapping circular lines in various colors (blue, purple, white) that resemble orbital paths or data trajectories. The overall scene is set against a light blue gradient with a field of small, bright white stars or data points scattered throughout.

COMPANY PROFILE

Inspiring Creativity in People and Companies

The creative power of people brings advances to life, industry and communities.

At MUTOH, our mission is to deliver products and services that ignite the imaginations of people and companies alike. A manufacturing professional with an impressive track record, MUTOH is uniquely positioned to build value through creativity.



INSPIRATION

From Inspiration to **Admiration**

We are the experts at expressing designers' intent with scintillating clarity, widening the circle of excitement.

IDEA

From Ideas to **Delight**

We support customers' IT ideas from planning to design. Bringing excitement to designers' dreams is our specialty.

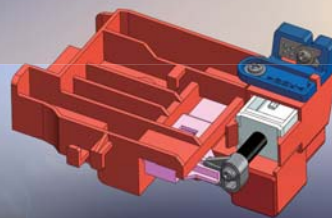
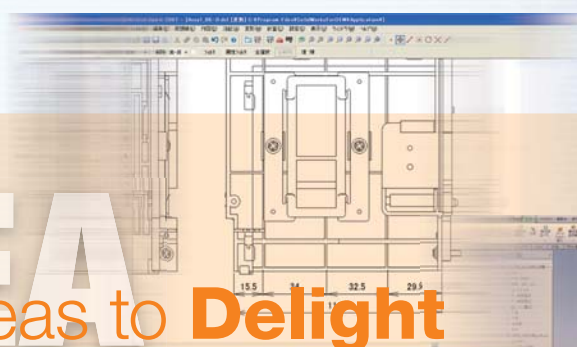

From Images to a **Common Understanding**

We speak the language of technical drawings, the language of designers. We expand the discussion from "getting it produced" to "attracting the admiration of the market."

IMAGE



With constant innovation and challenging ourselves, we contribute to society.

**MUTOH is a corporate group dedicated to
the unceasing creation and presentation of new value.**

Offering products ranging from drafters to pen plotters, CAD/CAM, and inkjet printers, and seeking always to actualize our philosophy that every object that has form can be rendered graphically, MUTOH's innovations in drafting and design are focused on providing support for creativity in manufacturing.

Our commitment to the support of creative manufacturing has remained unchanged since our restructuring into a holdings company.

In our major area of business, the development, manufacture, and marketing of large-format inkjet printers (imaging and information business), we have established subsidiaries in Europe, the US, Asia, Oceania and other regions worldwide, with MUTOH Industries, Ltd., our core company, as the driving force. Against the background of our continuing growth as a global corporate group, MUTOH's technological excellence is winning accolades from large numbers of customers throughout the world.

“In compliance with all pertinent laws, regulations, and social ethics in and outside Japan, and with conscientious corporate activities, we shall enhance the group business values, permanently maintain and expand our MUTOH brands, and endeavor to contribute to the healthy development of society.” In keeping with this philosophy, we are strengthening product development and service systems emphasizing improvement of customer satisfaction levels and buildup of business bases, to secure steady profits and improvements in performance.

MUTOH will focus on planning and implementing our strategies to optimize our management resources and expedite decision-making to cope with market changes. Furthermore we will also make every effort to globally expand the existing businesses and to create new business opportunities.

MUTOH contributes to the creation of new value based on a unique corporate perspective. We will continue to rise to the challenges presented by our wide-ranging areas of business, encompassing fields including digital measurement devices, sports support, and drafting and design equipment businesses in addition to our manufacturing solutions (information services) business, through which we provide consistent support for our customers' creative manufacturing endeavors.

Our customers can continue to rely on MUTOH into the future, and we hope that we may also rely on their ongoing support.

Nobumasa Hayakawa
President and Representative Director
MUTOH HOLDINGS CO., LTD.



■ Group Companies

【Corporate Management of Group Companies / Group Asset Management】

- MUTOH HOLDINGS CO., LTD. Headquarters: 3-1-3, Ikejiri, Setagaya-ku, Tokyo
Tel: 03-6758-7100 Fax: 03-6758-7106
Established: March 5, 1952 (Founded December 1942)
Capital: ¥10,199 million
Fiscal year-end: March
Chairman: Masanori Takayama (Director)
President: Nobumasa Hayakawa (Representative Director)
Date of listing: Tokyo Stock Exchange First Section: March 1, 1985

Domestic

【Development, manufacture, sales, maintenance, and servicing of imaging and information equipment】 (inkjet printers, plotters, 3D printers, and image scanners)

- MUTOH INDUSTRIES LTD. Headquarters: 3-1-3, Ikejiri, Setagaya-ku, Tokyo
Tel: 03-6758-7000 Fax: 03-6758-7007
Suwa Factory: 3128, Shimo-suwa-cho, Suwa-gun, Nagano
Tel: 0266-28-1881 Fax: 0266-28-1335

【Development, manufacture, and sales of drafting and design equipment, CAD/CAM,】 optical measuring instruments, and environmental products】

- MUTOH ENGINEERING INC. 3-1-3, Ikejiri, Setagaya-ku, Tokyo
Tel: 03-6758-7120 Fax: 03-6758-7129

【Import, development, manufacture, and sales of sports equipment】

- MUTOH ENTERPRISES LTD. 3-1-3, Ikejiri, Setagaya-ku, Tokyo
Tel: 03-6758-7140 Fax: 03-6758-7141

【System solutions services, application software development】

- MUTOH ITEX Co., Ltd. 3-1-3, Ikejiri, Setagaya-ku, Tokyo
Tel: 03-6758-7080 Fax: 03-6758-7089

Overseas

【Sales of imaging and information equipment】

- MUTOH AMERICA INC. 2602 South 47th Street, Suite 102, Phoenix, Arizona 85034 USA
Tel: 480-968-7772 Fax: 480-968-7990
Boston Branch / Tel: 781-569-5988
Atlanta Branch / Tel: 678-966-9442
Chicago Branch / Tel: 847-483-9107
Los Angeles Branch / Tel: 310-375-2731
- MUTOH Belgium nv Archimedesstraat 13, 8400 Oostende, Belgium
Tel: 32-59-561400 Fax: 32-59-807117
- MUTOH Deutschland GmbH Schiess-Strasse 68, 40549 Düsseldorf, Germany
Tel: 49-211-385474-0 Fax: 49-211-385474-74
- MUTOH North Europe S.A. 6, place de Nancy, L-2212 Luxembourg
Tel: 352-445-906 Fax: 352-447-093
Sericomex Sweden / Tel: 46-418-450-180
Sesoma Finland / Tel: 358-20-745-9630
Sesoma Estonia / Tel: 372-654-0114
Sesoma Latvia / Tel: 371-675-011-41
Sesoma Lithuania / Tel: 370-37-452-776
- MUTOH HONG KONG LIMITED Suite 1426A, 14Fl., Ocean Center, Harbour City, Kowloon, Hong Kong, PRC
Tel: 852-2377-3411 Fax: 852-2377-3422
- MUTOH SINGAPORE PTE. LTD. 138 Robinson Road #19-09/10 The Corporate Office, Singapore 068906
Tel: 65-6325-3150 Fax: 65-6220-4342
- MUTOH AUSTRALIA PTY. LTD. Unit 19, 76 Reserve Road, Artarmon NSW 2064 Australia
Tel: 61-2-9437-1366 Fax: 61-2-9436-2871



Business Description

As the core company in the MUTOH Group, MUTOH INDUSTRIES creates and supplies maximum value to meet customer needs.

MUTOH INDUSTRIES plays a central role in the development, manufacture, and sales of the products and services offered by the MUTOH Group. We are developing our Imaging and Information Business to identify where our customers do business and to provide them with the best proposals and highest value.

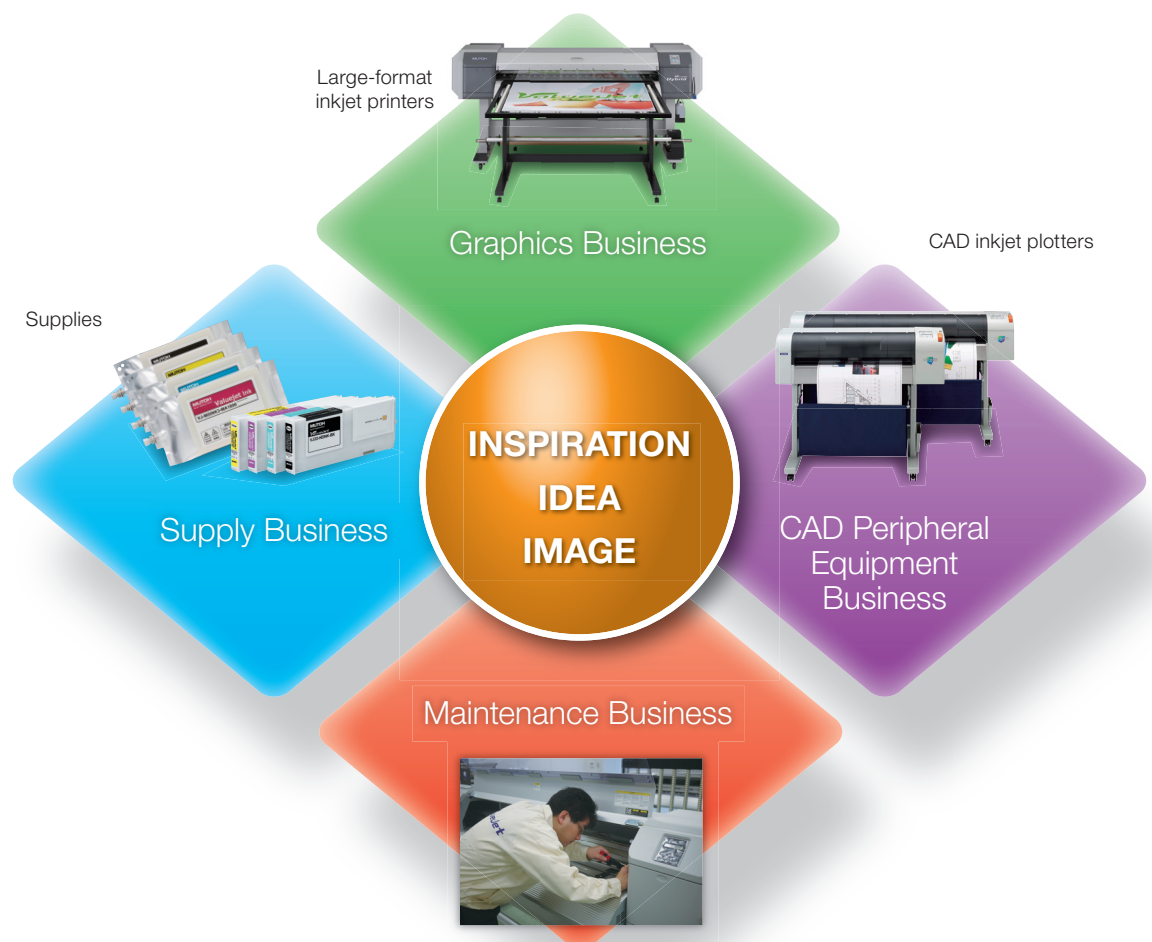

Focusing on the development, manufacture, sales, and maintenance of large-format inkjet printers for graphics and CAD inkjet plotters, we leverage our core technologies to support efficiency improvements in workplace operations by supplying products that meet customer needs.

As the leading manufacturer of large-format inkjet printers and plotters, we offer solutions and satisfaction that stay one step ahead of the needs of today's professionals.

Company Profile

Trade name MUTOH INDUSTRIES LTD.
 Headquarters 3-1-3, Ikejiri, Setagaya-ku, Tokyo
 Tel: 03-6758-7100 Fax: 03-6758-7007
 Home Page <http://www.mutoh.co.jp/>
 Established April 1, 2007
 (Split into MUTOH HOLDINGS CO., LTD.
 and MUTOH INDUSTRIES LTD.)
 Capital ¥350 million
 End of FY March

President Nobumasa Hayakawa
 (Representative Director)

- Key Businesses
- Development, manufacture, and sales of imaging and information equipment
 - Large-format inkjet printers
 - Inkjet plotters for CAD
 - Import and sales of 3D printers, image scanners
 - Maintenance and servicing of the above-listed products

MUTOH INDUSTRIES LTD. Locations

- Suwa Factory
3128, Shimo-Suwa-cho, Suwa-gun, Nagano
Tel: 0266-28-1881 Fax: 0266-28-1335
- Hokkaido Sales Office
Imperial 3 & 7 Bldg. 1st Floor, 7-346-1,
Kita-sanjou-higashi, Chuo-ku, Sapporo-shi, Hokkaido
Sales: Tel: 011-261-8810 Fax: 011-261-6207
Service: Tel: 011-261-8810 Fax: 011-261-6207
- Tohoku Sales Office
3-18-25, Shinden, Miyagino-ku, Sendai-shi, Miyagi
Sales: Tel: 022-283-6181 Fax: 022-283-6196
Service: Tel: 022-283-6190 Fax: 022-283-6196
- Shutoken Sales Office
3-1-3, Ikejiri, Setagaya-ku, Tokyo
Sales: Tel: 03-6758-7002 Fax: 03-6758-7012
Service: Tel: 03-6758-7003 Fax: 03-6758-7012
- Chubu Sales Office
2-8, Himeike-dori, Chikusa-ku, Nagoya-shi, Aichi
Sales: Tel: 052-761-5171 Fax: 052-762-5190
Service: Tel: 052-751-7321 Fax: 052-751-7345
- Hokuriku Service Office
3-9-16, Izuminode-machi, Kanazawa-shi, Ishikawa
Service: Tel: 076-243-1120 Fax: 076-243-1124
- Kansai Sales Office
Daiichi-kasai Senri Chuo Bldg. 1st Floor, 1-1-8,
Shinsenri-nishi-machi, Toyonaka-shi, Osaka
Sales: Tel: 06-6871-8601 Fax: 06-6871-8091
Service: Tel: 06-6871-8611 Fax: 06-6871-8091
- Chugoku & Shikoku Sales Office
3-15-9, Oshiba, Nishi-ku, Hiroshima-shi, Hiroshima
Sales: Tel: 082-237-2541 Fax: 082-237-2387
Service: Tel: 082-230-2116 Fax: 082-237-2387
- Kyushu Sales Office
2-4-9, Higashi-Naka, Hakata-ku, Fukuoka-shi, Fukuoka
Sales: Tel: 092-441-0316 Fax: 092-441-3980
Service: Tel: 092-451-6318 Fax: 092-441-3980
- MUTOH Yokohama Distribution Center
37-1, Iijima-cho, Sakae-ku, Yokohama-shi, Kanagawa
Tel: 045-897-4120 Fax: 045-897-4122

MUTOH Showroom Designing Gallery (Headquarters 1st Floor)

The MUTOH Designing Gallery is a space where visitors can see, touch, and feel the MUTOH brand. In addition to displays of the most recent machines and car wrappings, the gallery features an introduction to the history of the MUTOH group, space for product demonstrations, and space for business meetings.



Gallery space



Meeting space



Demonstration space

Development, manufacturing, and sales structure

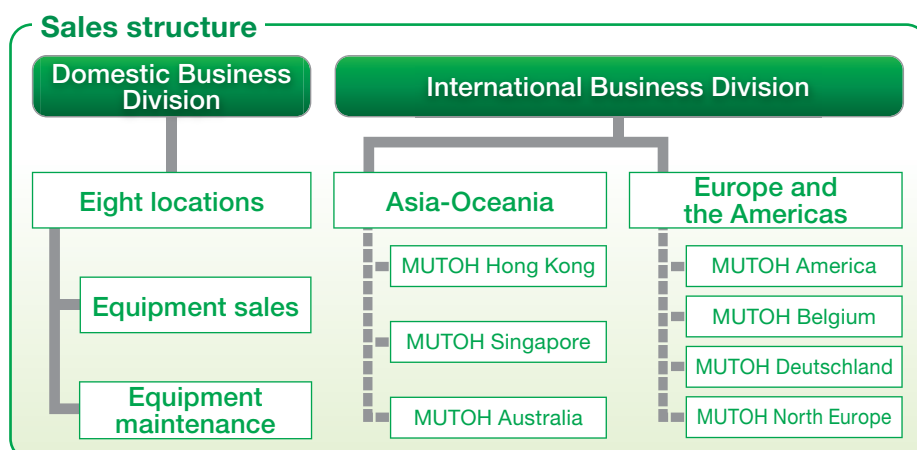

Development and manufacturing structure

Development Center

Suwa Factory

Imaging and Information Business

Delivering equipment and services that are one step ahead of the needs of industry pros.



Global strategic model large-format inkjet printers

ValueJet



Global strategic model CAD inkjet plotters

DrafStation

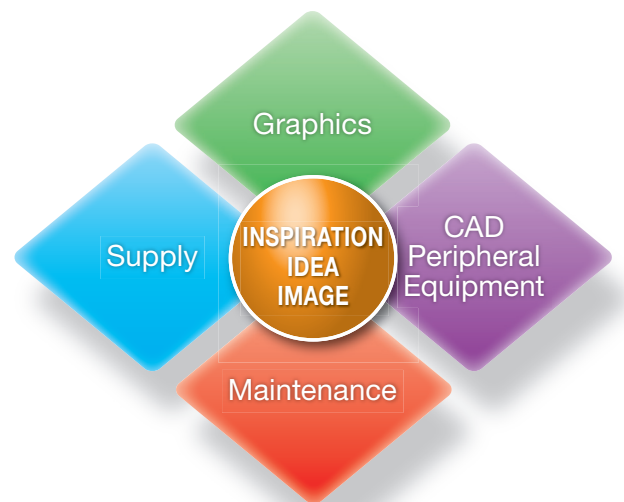

In 1953, MUTOH produced Japan's first drafting and design tool, the Drafter, and later produced the Numericon, an automatic drawing device that spurred the evolution of the plotters that would precede later CAD devices. We also produced Japan's first large-format inkjet printer for outdoor applications, the RJ-1300, which created new value for the world of graphic arts. As a pioneer in its field, MUTOH has always delivered products that breathe new life into the industry, and our corporate DNA in this regard has been passed on in pure form to our Imaging and Information Business.

The Imaging and Information Business is comprised of four business segments: the Graphics Business, which centers around large-format inkjet printers used for a variety of applications from gigantic billboards to interior graphic arts; the CAD Peripheral Equipment Business, which can meet needs ranging from inkjet plotters and pen plotters to 3D printers, large-format color scanners, and design and drawing tools; the Supply Business, which ensures quick delivery of supplies; and the Maintenance Business, which offers maintenance services for imaging and information equipment. We can meet professional needs with an integrated system that seamlessly covers everything from hardware and supplies to maintenance and servicing.

Graphics Business

MUTOH's global ValueJet brand has received high acclaim for having a strong lineup of tools that offer outstanding cost-performance and ease of use, and that can be used for a variety of applications. It's a brand that delivers high value to professionals worldwide.

ValueJet offers beautiful print quality that is well-suited to various media needs and environmental conditions thanks to the renowned control technologies of MUTOH, a pioneer in large-format inkjet printers. We are always striving to challenge ourselves to new heights, as in such areas as our internally developed color-measurement devices and environmentally functional inks, and we cooperate with our users in the creation of new businesses.



CAD Peripheral Equipment Business

We have a full lineup of CAD peripheral equipment, including DrafStation, an inkjet plotter whose advanced control technologies for paper feeding and ink delivery have given it a solid reputation among professional users for its ability to accurately and beautifully express the drawings of designers. Our other products include 3D printers that can create 3D models of designers' images easily and quickly, and large-format color scanners that are able to meet current needs for image digitization. We also offer products for specific industries, such as cutting plotters for use in apparel applications.

We fully support the design industry with regard to quality, speed, and cost-performance.



Supply and Maintenance Businesses

The Supply Business aims to meet the needs of a diverse range of professional users by offering supplies that include ink and media for large-format inkjet printers and CAD inkjet plotters. It focuses on strict quality control and prompt delivery.

The Maintenance Business adheres to the principle of viewing the customer as number one. It seeks to improve customer satisfaction by offering excellent services performed by technicians with a wealth of experience and the technical skills needed to do the job. More than just making repairs when parts malfunction, we think carefully about our customers' business conditions and approach maintenance by asking what steps need to be taken to prevent breakdowns from occurring in the first place.



Global Sales System

Globally promoting the MUTOH brand strategy, delivering products and services that help increase value for customers.



MUTOH

- MUTOH Belgium nv
- MUTOH Deutschland GmbH
- MUTOH North Europe S.A.
 - Sweden Sales Office
 - Finland Sales Office
 - Estonia Sales Office
 - Latvia Sales Office
 - Lithuania Sales Office
- MUTOH SINGAPORE PTE. LTD.
- MUTOH HONG KONG LIMITED
- MUTOH INDUSTRIES LTD.
 - MUTOH AUSTRALIA PTY. LTD.
 - MUTOH AMERICA INC.
 - Boston Branch
 - Atlanta Branch
 - Chicago Branch
 - Los Angeles Branch



In the field of imaging and information equipment, MUTOH's mission in international business is to offer a single integrated brand on a global scale. We have developed a series of large-format inkjet printers around the ValueJet brand to serve as global strategic models, and we are hoping to establish these, along with our DrafStation CAD inkjet plotter, as the global standard.

In the growing markets of Asia, South America, and Central and Eastern Europe we are strengthening and solidifying our customer-oriented sales and service systems by establishing sales subsidiaries and cultivating new retailers. In the more mature markets of Europe and the US, we strive to deliver products and services that stay one step ahead of our customers' needs, primarily by working to uncover and cultivate new markets.

Development and Production Systems

Our growth is driven by a workplace-focused approach to development, which seeks to offer products that help our customers drive their businesses forward, combined with our painstakingly built technological capabilities and our passion for achieving the highest quality.

Delivering the MUTOH brand from Suwa to the world.

Our Development Center, the hub of development of MUTOH brand products, and the Suwa Factory, which manufactures those products, are located in the same complex. High-quality products made through an integrated development and production system, based on customer needs, are delivered around the globe to customers in Japan and the rest of Asia, Oceania, Europe, and the Americas. The Suwa Factory is the launching pad for MUTOH's globally integrated brand.

Development Center



Suwa Factory



To manufacture products that offer the highest level of value to customers, MUTOH develops products from a workplace-oriented approach. The sales staff and development staff work together to share information on business issues faced by customers and to ensure that those issues are addressed in product development.

By quickly incorporating these solutions into production lines, MUTOH can quickly deliver products based on needs that arise in the workplace.



Information Service Business

Total solutions proposed for the challenges and issues faced by design and production sites.

MUTOH provides total system solutions encompassing drafting to maintenance of production equipment. Our production control and inventory control software can combine production goods and technologies around the world to support global operations.

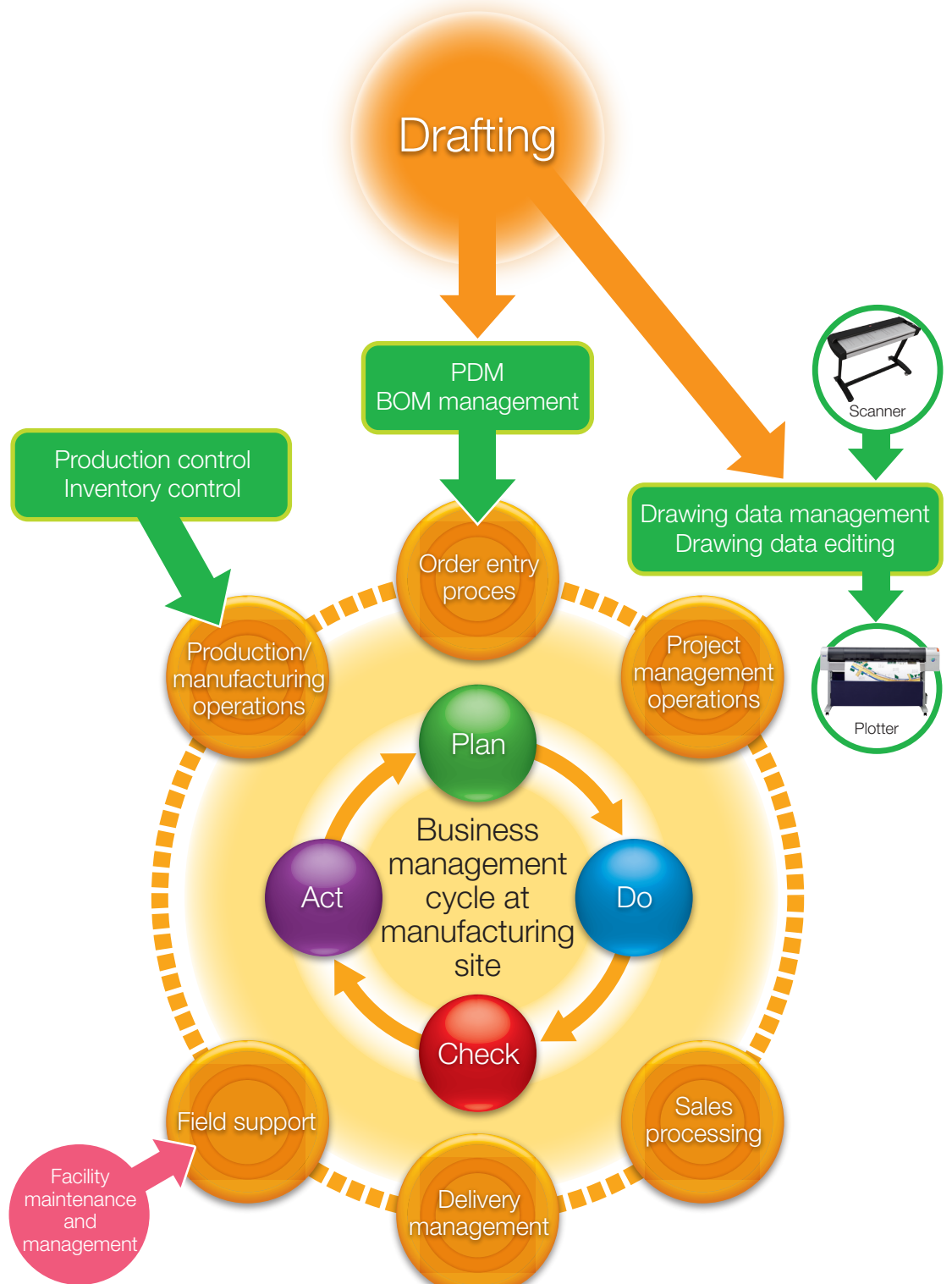

MUTOH offers a customized set of solutions according to the customer's needs, leading the way to overcoming challenges.

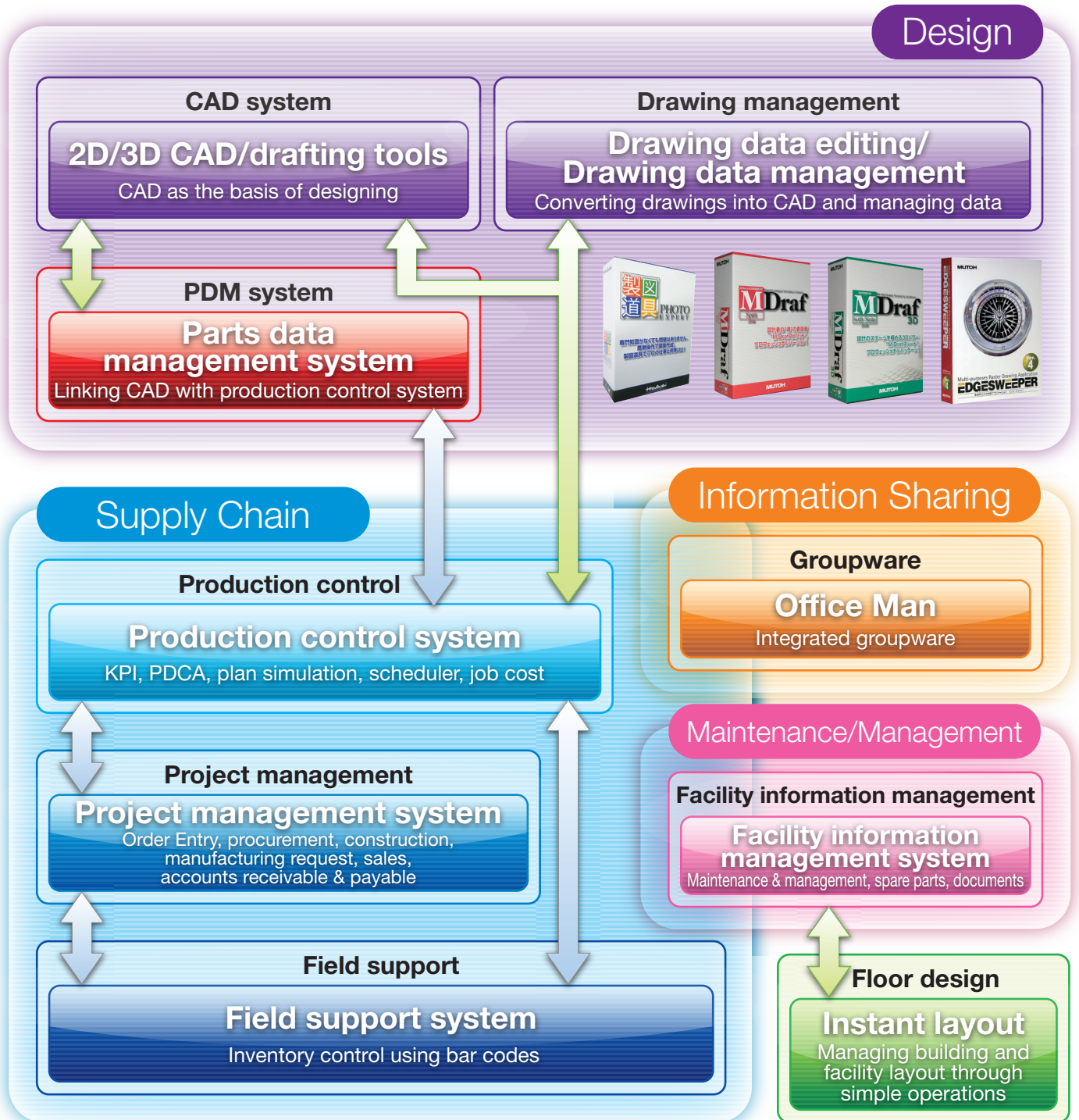

MUTOH provides support—from consulting to operations—based on reliable technology

Prompt response to changes in product needs

Improved productivity by consolidating information dispersed across departments

Realizing low-cost production

Introduction to Other Businesses

MUTOH engages in a variety of businesses. Our technological skills are not a product of existing frameworks, but have evolved through an array of creative manufacturing efforts aimed at developing new merchandise and cultivating new sales channels.

» Drawing and Design Business

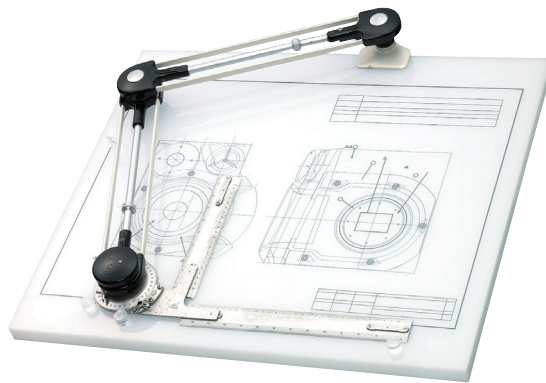

Drafter No. 1 was certified as a Mechanical Engineering Heritage item.

» Measurement and Control Devices Business



» Environmental Products Business



» Sports Support Products Business



Drawing and Design Business

The Drafter elevated MUTOH to a global brand. Even today these devices are widely used in schools and corporate education environments.



Measurement and Control Devices Business

The Measurement and Control Devices Business is typified by industrial machines and the Digicolor, a high-precision measurement and control device used in engineering applications.



Environmental Products Business

This business develops, manufactures, and sells LED products and other new products that offer innovative designs, low energy consumption, and minimal heat generation.



Sports Support Products Business

This business imports, develops, manufactures, and sells athletic products that support comfortable movement during sports and other everyday activities.

